



www.acrn.fr

ACRN

Quality Control Machine
Industry & Packaging

MULTITEST-DV



**MOTORIZED TRACTION/
COMPRESSION STAND**

MULTITEST-DV

MOTORIZED TRACTION/ COMPRESSION STAND

FUNCTION

The Mutitest-DV is a versatile and compact motorized test bench, offering excellent value for money. It allows to realize precise tensile / compression tests, in particular thanks to its sophisticated electronic components and its ergonomic control plate.

This single-column bench offers a wide range of functions, especially when it combined with an advanced force sensor. In addition, coupled with high-performance software, it will be easy for you to fully trace and process your acquisition data.

Finally, thanks to the multiple adaptable accessories on the stand, it will be able to fully meet your needs while staying as close as possible to your budget. Its small size and robustness will facilitate testing in the production area and provide quality control in the laboratory.

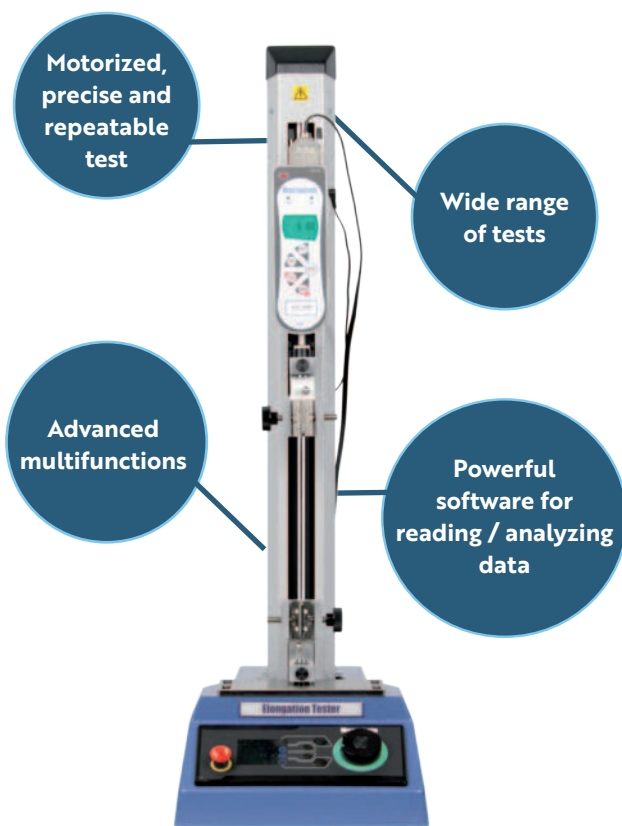

TECHNICAL INFORMATION

Capacities	0.5 kN	1 kN	2,5 kN
Mountable sensors	Digital force gauge, force sensor		
Test mode	- manual traction / compression - between 2 trips - between 2 limits - between 2 loads		
2 level tests with digital force gauge AFG	Autonomus - Peak value - Displacement limit		Connected to the bench - Load limit - Break limit
Displacement resolution	0.001 mm		
Position precision	+/- 0.130/300 mm		
Velocity range Nb test/ cycle	0.1 to 1200 mm/min 9 999		
Velocity resolution	0.1 mm/min		
Velocity precision	+/- 0.2 % of the indicated velocity		
Power supply	230V AC 50 Hz / 110V AC 60 Hz		
Power	120 W	200 W	250 W
Safety	Lockable thumbwheel		

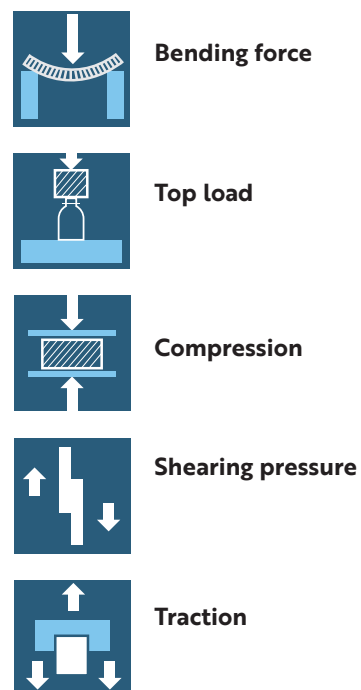

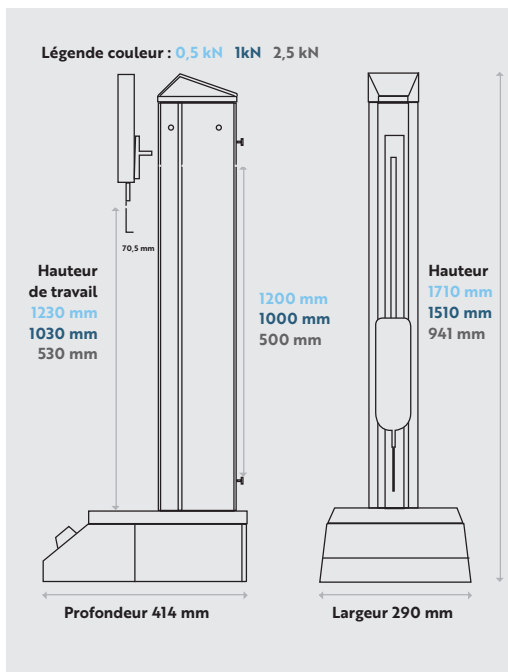

VECTOR PRO LITE

● Program creation

- Test permissions
- Test operation
- Résultats : area calculation, average, adjustment, peak, etc.

● Real-time curve

- Instant calculation
- Compliant / non-compliant result
- Revisions results: curve comparison, invert axes, zoom, etc.

● Processing results

- Graph comparison
- Parameter adjustment
- Export of raw data or in the form of tables, in Excel or PDF format for test reports.

OPTIONS

Vector Pro Lite Software	Connection with Stand + AFG or BFG
Vector pro MT Software	Connection with Stand + ELC (material test)

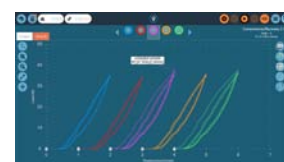

Test Status: 5 cycle (20 mm PE Foam Recovery)

Test Name: Compression (20mm PE)

Sample	Area(Nmm)	First Peak(N)	Last Peak(N)
S.1	12000	3000	2500
S.2	10000	2500	2000
S.3	15000	3500	3000
S.4	18000	4000	3500
S.5	14000	3200	2800
S.6	16000	3800	3200
S.7	13000	3000	2500
S.8	11000	2800	2200

VARIOUS APPLICATIONS:



● Extraction



● Bending



● Insertion

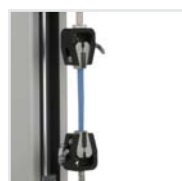

● Traction



● Compression



● Lengthening at the break

MAIN ACCESSORIES:



● Rotation Crimp Receptacle



● Wedge Grip traction / tearing

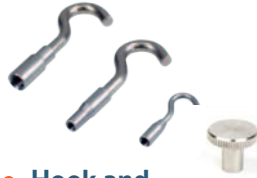

● Hook and compression plate



● Cable Cam Grip Cable traction



● Multijaw Particulary Cork traction (any material)

ACRN A GLOBAL OFFER
for your packaging quality controls

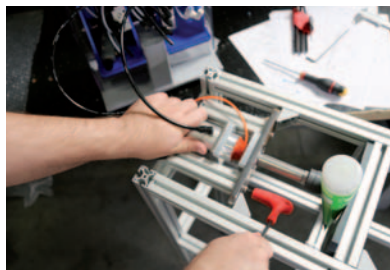

Calibration and annual maintenance

ACRN is equipped with a metrology laboratory.

Setting up tests, choice of materials, state of the art, work on repeatability

we can advise you according to your needs (technology, budget, ergonomics).

Leak testing and dynamometric testing

Our skills and equipments for leak testing and dynamometric testing for packaging

Major manufacturers have trusted us for many years

